

# MiniController

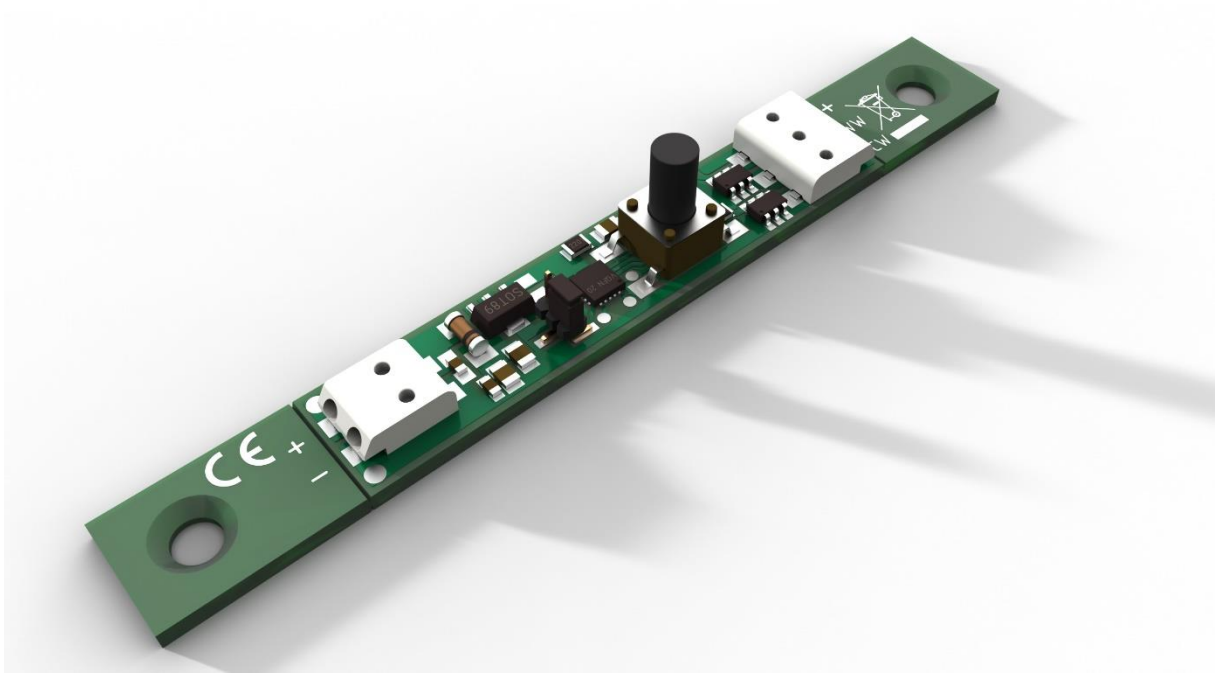

## FEATURES

- Tunable White control unit with dimming function and Dim2Warm mode
- For controlling constant voltage LED modules (output voltage from 12 - 30V)
- Input voltage depending on LED module (12 - 30V)
- Small dimensions (80 x 10 x 10.1 mm)
- High current carrying capacity of up to 2.5 A per channel
- High output power of up to 75 W (at 30V)
- Very low standby power of < 90 mW over the entire voltage range
- Dim2Warm can be activated by removing jumper (standard mode: Tunable White)
  - Dim2Warm: When dimming down, the colour temperature is reduced  
z. B. cosy atmosphere in the living room
  - The maximum color temperature (Dim2Warm) and the maximum brightness can be set and freely selected.
- Memory function: The brightness and colour temperature values are retained even when power is off
- Maintaining mains reversal
- Connection pads for an external pushbutton are provided on the printed circuit board.
- Holes for M3 screws for easy mounting
- 5 years warranty
- Made in Germany

## APPLICATIONS

- Ideal for controlling all types of luminaires with Tunable White LED modules, e.g.:
  - Ceiling lights
  - Industrial lighting
  - Floor lamps
  - Wall lights
  - Pendant luminaires
- Excellent for controlling the following LUMITRONIX® Tunable White products:
  - LumiFlex
  - SlimFlex
  - BackMatrix
  - SmartArray 24V

**TECHNISCHE DATEN**

LUMITRONIX article number	51162
Article Description	MiniController
Classification	Professional
Electrical data (input)	
Operating mode	Constant voltage
Voltage [V]	12 to 30
Current [mA]	2500
Power consumption in Operation [mW]	225
Power consumption in Standby [mW]	90
Cable cross-section [mm <sup>2</sup> ]	0,14 to 0,35
Electrical data (output)	
Type of control	PWM
Voltage [V]	Identical Input voltage
Current [mA]	2500
Power [W]	30 (at 12 V) / 60 (at 24 V) / 75 (at 30 V)
Frequency [Hz]	1420
Cable cross-section [mm <sup>2</sup> ]	0,14 to 0,35
Interfaces	
Push button	yes
Safety and security	
Short-circuit protection	no
Overvoltage Protection	no
Overload Protection	no
Overtemperature Protection	no
Dimensions / Mechanical data	
Length [Mm]	80
Width [Mm]	10
Height [Mm]	10,1
Weight [G]	4
Temperatures	
Operating Temperature At TC	0°C to +70°C
Storage Temperature	-40°C to +85°C
Scope Of Delivery	
Self-Adhesive Film	no
Scope Of Delivery	1 x MiniController
Warranty (German)	5 Years
Approvals / Certifications	
CE Declaration	yes
Rohs	yes
Reach	yes

**DRAWING**

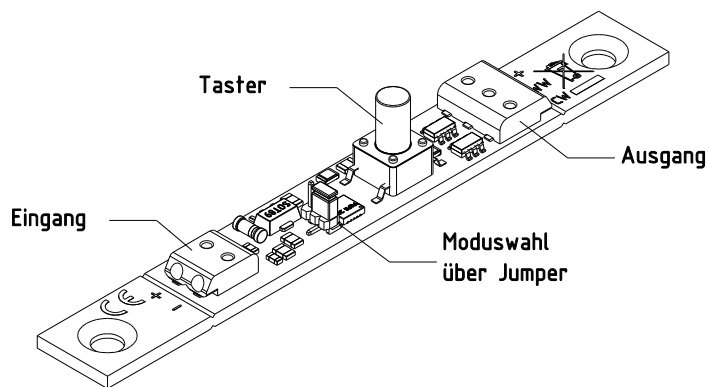
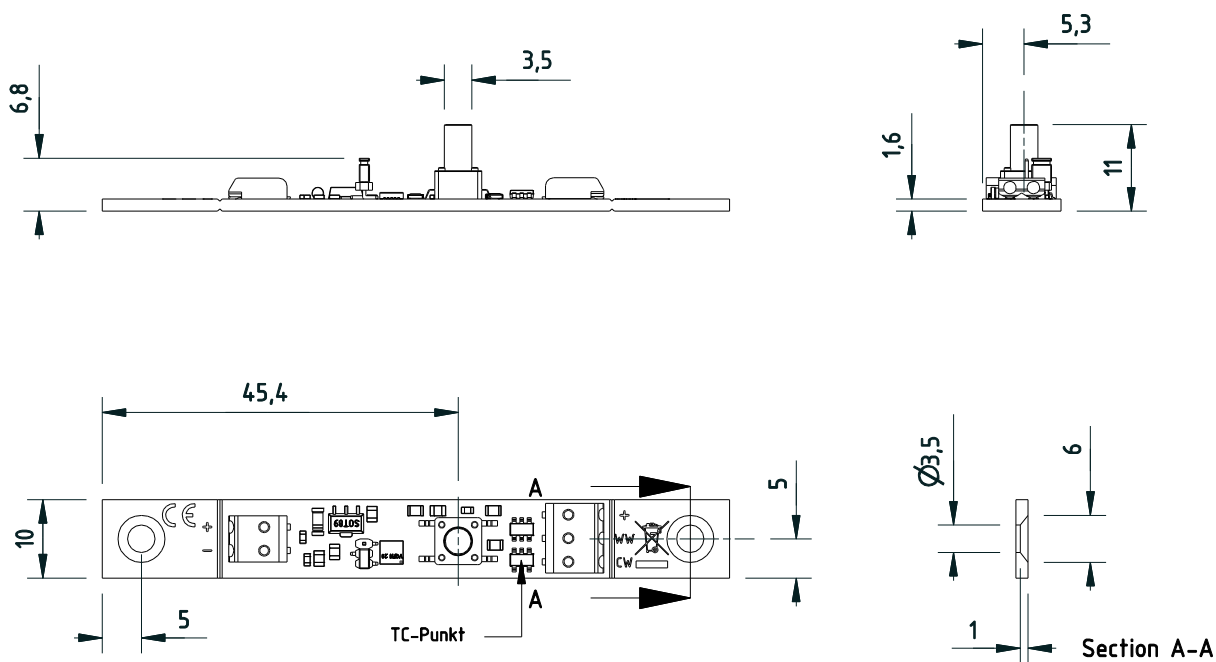

## CONNECTION

Connect the 2-pole WAGO terminal at the input with the supply voltage.

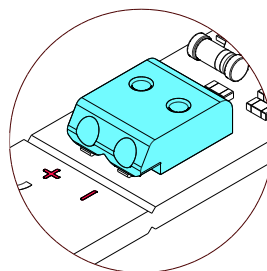

At the output there is a 3-pole WAGO terminal, to which the LED modules are connected.

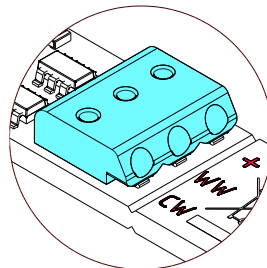

## CONFIGURATION

Brightness and colour temperature are set with the push-button on the MiniController.

In all modes, the set values are saved, even after an loss of power supply.

In the "Color temperature" and "Brightness" modes you can set maximum values for the "Dim2Warm" mode.

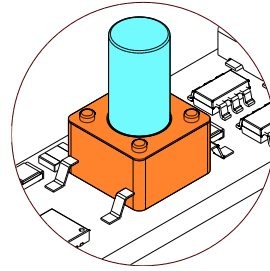

### **Dim2Warm – No Jumper**

When the button is pressed, the dimmer changes brightness and color temperature at the same time. If no maximum values have been set, the color temperature and brightness are changed over the entire available range.

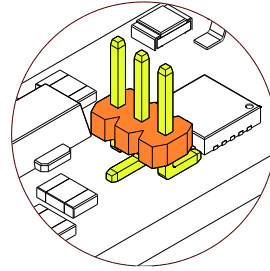

### **Colour temperature – Jumper down**

When the button is pressed, the dimmer changes only the color temperature. In this mode you can set the maximum color temperature for the Dim2Warm function. To do this press the button until reaching the desired value then remove the jumper. This will be the maximum color temperature. To change put the jumper back and repeat.

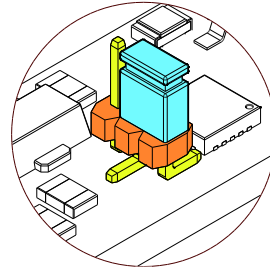

### **Brightness – Jumper up**

When the button is pressed, the dimmer changes only the brightness.

In this mode you can set the maximum brightness for the Dim2Warm function. To do this press the button until reaching the desired value then remove the jumper. This will be the maximum brightness. To change put the jumper back and repeat.

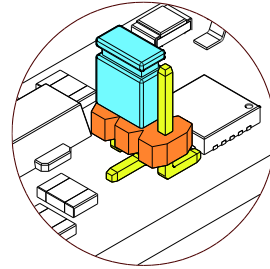

## DIMMING CHARACTERISTICS (Dim2Warm)

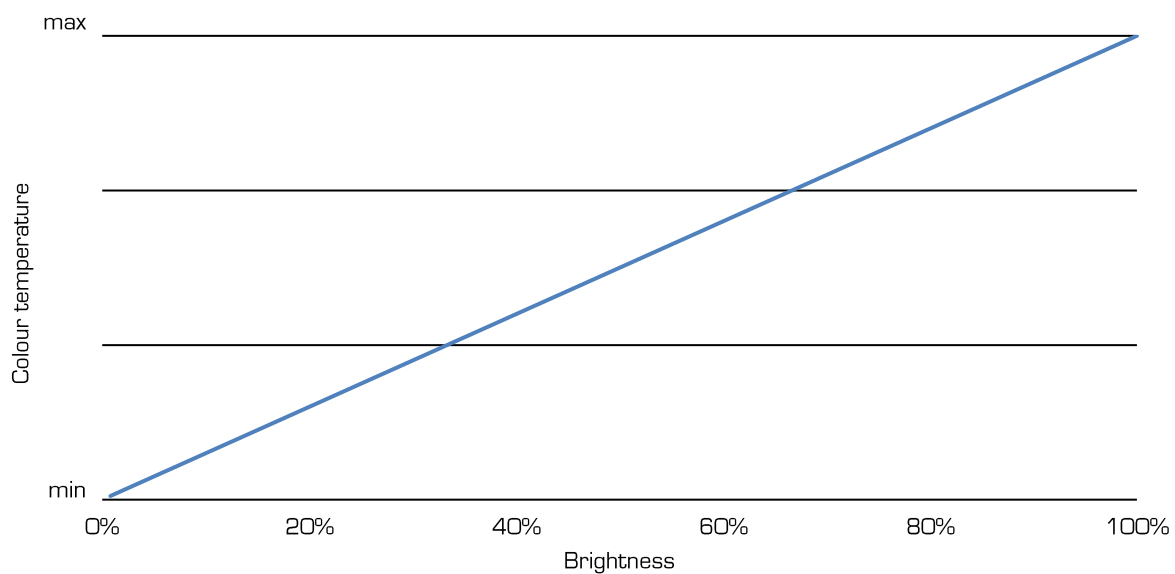

## SICHERHEITSHINWEISE

The LED controllers and all their components must not be subjected to mechanical stress.

Avoid excessive force, e.g. by screwing or bending too much.

The installation of the module (with control gear) must be carried out taking into account all applicable electrical and safety standards. Observe standard ESD precautions when installing the modules.

- The components on the LED controller must not be subjected to mechanical stress.
- The conductor tracks on the circuit boards must not be damaged during installation, or interrupted.

Our LED controllers are not protected against overload, overtemperature and short-circuit currents. In order to operate the controllers safely and reliably, it is therefore necessary to use an electronically stabilized power supply in which these safety functions are already integrated. If power supplies other than those sold by us are used, the following protective measures must be ensured on the power supply side:

### MINIMUM REQUIREMENTS FOR POWER SUPPLIES

Short-circuit protection • Overload protection • Overtemperature protection

- The installation of LED controllers (with power supply unit) must only be carried out in compliance with all applicable regulations and standards, and must be carried out by an authorised electrician.

### IF YOU HAVE ANY QUESTIONS WE WILL BE HAPPY TO HELP YOU

LUMITRONIX® is your partner for light emitting diodes, LED products and light measurement.



LUMITRONIX® LED-Technik GmbH  
Haigerlocher Str. 42  
72379 Hechingen, Germany

LED Shop: <http://www.lumitronix.com>  
Forum: <http://www.lumitronixforum.de>  
E-Mail: [mail@lumitronix.com](mailto:mail@lumitronix.com)

Central +49 (0) 7471 / 960140  
Fax +49 (0) 7471 / 96014-99

UStIdNr. DE 814318271  
Local Court Stuttgart  
HRB 421019 12.04.05

Passing on as well as duplication of this document, utilization and communication of its contents are forbidden as far as not expressly permitted. Violations will result in damages.

All rights reserved in the event of patent, utility model or design registration.

Subject to technical changes