

NICHIA CORPORATION

SPECIFICATIONS FOR WARM WHITE LED

NVSLE21AT

- Pb-free Reflow Soldering Application
- RoHS Compliant

SPECIFICATIONS

(1) Absolute Maximum Ratings

Item	Symbol	Absolute Maximum Rating	Unit
Forward Current	I_F	1400	mA
Pulse Forward Current	I_{FP}	2000	mA
Reverse Voltage	V_R	5	V
Power Dissipation	P_D	4.62	W
Operating Temperature	T_{opr}	-40~100	°C
Storage Temperature	T_{stg}	-40~100	°C
Junction Temperature	T_J	135	°C

* Absolute Maximum Ratings at $T_C=25^\circ\text{C}$.

* I_{FP} conditions with pulse width $\leq 10\text{ms}$ and duty cycle $\leq 10\%$.

(2) Initial Electrical/Optical Characteristics

Item		Symbol	Condition	Typ	Max	Unit
Forward Voltage		V_F	$I_F=700\text{mA}$	3.0	-	V
Reverse Current		I_R	$V_R=5\text{V}$	-	-	μA
R70	Luminous Flux	Φ_v	$I_F=700\text{mA}$	283	-	lm
	Color Rendering Index	R_a	$I_F=700\text{mA}$	72	-	-
R8000	Luminous Flux	Φ_v	$I_F=700\text{mA}$	256	-	lm
	Color Rendering Index	R_a	$I_F=700\text{mA}$	82	-	-
R9050	Luminous Flux	Φ_v	$I_F=700\text{mA}$	206	-	lm
	Color Rendering Index	R_a	$I_F=700\text{mA}$	92	-	-
R9080	Luminous Flux	Φ_v	$I_F=700\text{mA}$	204	-	lm
	Color Rendering Index	R_a	$I_F=700\text{mA}$	92	-	-
Chromaticity Coordinate	x	-	$I_F=700\text{mA}$	0.4338	-	-
	y	-	$I_F=700\text{mA}$	0.4030	-	-
Thermal Resistance		$R_{\theta JC}$	-	0.3	0.6	°C/W

* Characteristics at $T_C=25^\circ\text{C}$.

* Luminous Flux value as per CIE 127:2007 standard.

* Chromaticity Coordinates as per CIE 1931 Chromaticity Chart.

* The thermal resistance value ($R_{\theta JC}$) is used to perform logical analysis (e.g. computer-based thermal analysis simulation) and represents a thermal resistance between the die to the T_C measurement point (PCB used: Aluminum PCB $t=1.5\text{mm}$, Insulating layer $t=0.12\text{mm}$).

* For more details on thermal resistance, see CAUTIONS, (6) Thermal Management.

RANKS

Item	Rank	Min	Max	Unit	
Forward Voltage	M21	3.2	3.3	V	
	M1	3.0	3.2		
	L2	2.8	3.0		
	L12	2.7	2.8		
Reverse Current	-	-	50	μA	
Luminous Flux	D320	320	340	lm	
	D300	300	320		
	D280	280	300		
	D260	260	280		
	D240	240	260		
	D220	220	240		
	D200	200	220		
	D180	180	200		
Color Rendering Index	R70	R _a	70	-	-
	R8000	R _a	80	-	-
		R ₉	0	-	-
	R9050	R _a	90	-	-
		R ₉	50	-	-
	R9080	R _a	90	-	-
		R ₉	80	-	-

Color Ranks

The color rank has a chromaticity range within a 3-step MacAdam ellipse.

		Rank sm273	Rank sm303	Rank sm353	Rank sm403	Rank sm453
Center Point	x	0.4578	0.4338	0.4073	0.3818	0.3611
	y	0.4101	0.4030	0.3917	0.3797	0.3658
Minor Axis	a	0.004056	0.004107	0.004098	0.004071	0.003852
Major Axis	b	0.007872	0.008391	0.008796	0.009282	0.009009
Ellipse Rotation Angle	Φ	-36.05	-36.00	-35.47	-35.95	-34.33

The color rank has a chromaticity range within a 5-step MacAdam ellipse.

		Rank sm275	Rank sm305	Rank sm355	Rank sm405	Rank sm455
Center Point	x	0.4578	0.4338	0.4073	0.3818	0.3611
	y	0.4101	0.4030	0.3917	0.3797	0.3658
Minor Axis	a	0.006760	0.006845	0.006830	0.006785	0.006420
Major Axis	b	0.013120	0.013985	0.014660	0.015470	0.015015
Ellipse Rotation Angle	Φ	-36.05	-36.00	-35.47	-35.95	-34.33

- * Ranking at T_c=25°C.
- * Forward Voltage Tolerance: ±0.05V
- * Luminous Flux Tolerance: ±6%
- * Color Rendering Index R_a Tolerance: ±2
- * Color Rendering Index R₉ Tolerance: ±6.5
- * The R₉ value for the above rank shall be greater than 0.
- * Chromaticity Coordinate Tolerance: ±0.006
- * LEDs from the above ranks will be shipped.

The rank combination ratio per shipment will be decided by Nichia.

Luminous Flux Ranks by Color Rank, Color Rendering Index Rank

Ranking by Color Coordinates, Color Rendering Index		Ranking by Luminous Flux		D160	D180	D200	D220	D240	D260	D280	D300	D320
		D160	D180	D200	D220	D240	D260	D280	D300	D320		
sm273,sm275	R70											
	R8000											
	R9050											
	R9080											
sm303,sm305	R70											
	R8000											
	R9050,R9080											
sm353,sm355	R70											
	R8000											
	R9050,R9080											
sm403,sm405, sm453,sm455	R70											
	R8000											
	R9050,R9080											

CHROMATICITY DIAGRAM

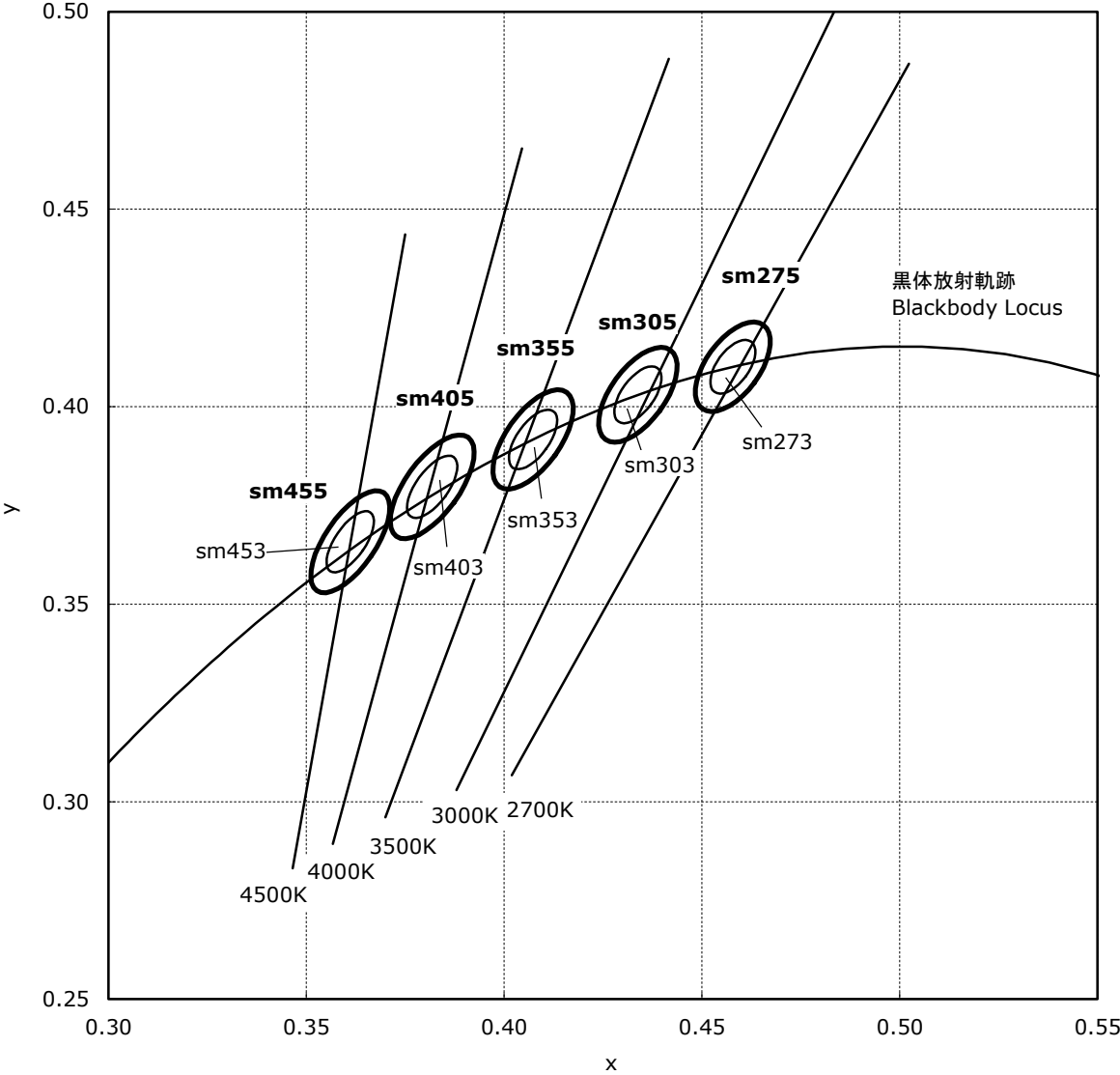

OUTLINE DIMENSIONS

* 本製品はRoHS指令に適合しております。
This product complies with RoHS Directive.

NVSLE21A
管理番号 No. STS-DA7-7891C

(単位 Unit: mm, 公差 Tolerance: ±0.1)

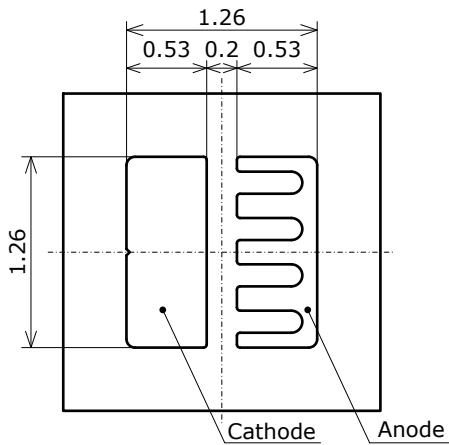
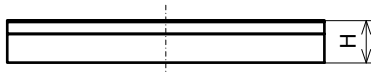
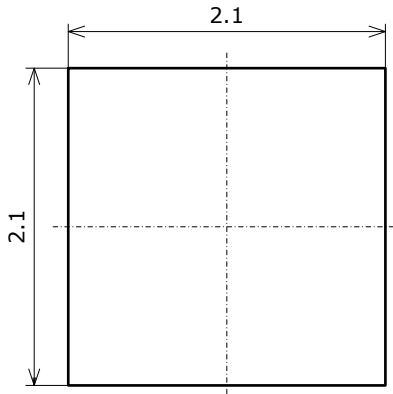

演色性ランク Color Rendering Index Rank	製品高さ H Height H
R70	0.27±0.05
R8000	0.30±0.05
R9050, R9080	0.35±0.05

項目 Item	内容 Description
パッケージ材質 Package Materials	シリコーン樹脂 Silicone Resin
蛍光体層材質 Phosphor sheet Materials	シリコーン樹脂 (拡散剤+蛍光体入り) Silicone Resin (with diffuser and phosphor)
電極材質 Electrodes Materials	金メッキ Au-plated
質量 Weight	0.0033g(TYP)

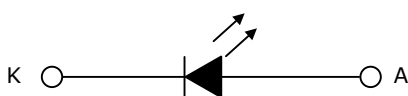

SOLDERING

- Reflow Soldering Condition(Lead-free Solder)

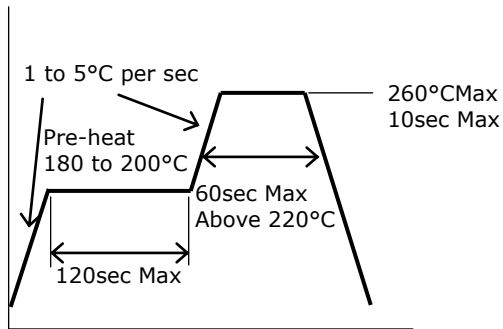

- Recommended Soldering Pad Pattern

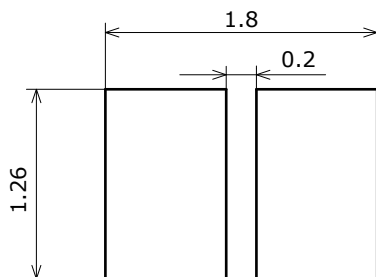

(單位 Unit: mm)

- * This LED is designed to be reflow soldered on to a PCB. If dip soldered or hand soldered, Nichia cannot guarantee its reliability.
- * Reflow soldering must not be performed more than twice.
- * Avoid rapid cooling. Ramp down the temperature gradually from the peak temperature.
- * Nitrogen reflow soldering is recommended. Air flow soldering conditions can cause optical degradation, caused by heat and/or atmosphere.
- * Since the silicone used in the encapsulating resin is soft, do not press on the encapsulant resin. Pressure can cause nicks, chip-outs, encapsulant delamination and deformation, and bump breaks, decreasing reliability.
- * Repairing should not be done after the LEDs have been soldered.
- * When soldering, do not apply stress to the LED while the LED is hot.
- * When using a pick and place machine, choose an appropriate nozzle for this product.
- * The recommended soldering pad pattern is designed for attachment of the LED without problems. When precise mounting accuracy is required, such as high-density mounting, ensure that the size and shape of the pad are suitable for the circuit design.
- * When flux is used, it should be a halogen free flux. Ensure that the manufacturing process is not designed in a manner where the flux will come in contact with the LEDs.
- * Make sure that there are no issues with the type and amount of solder that is being used.
- * All of the electrode pads are on the backside of this product; solder connections will not be able to be seen nor confirmed by a normal visual inspection. When using the product, ensure that there are no issues with the soldering conditions.

TAPE AND REEL DIMENSIONS

テーピング部 Tape

NxxxE21x
管理番号 No. STS-DA7-7890A

(単位 Unit: mm)

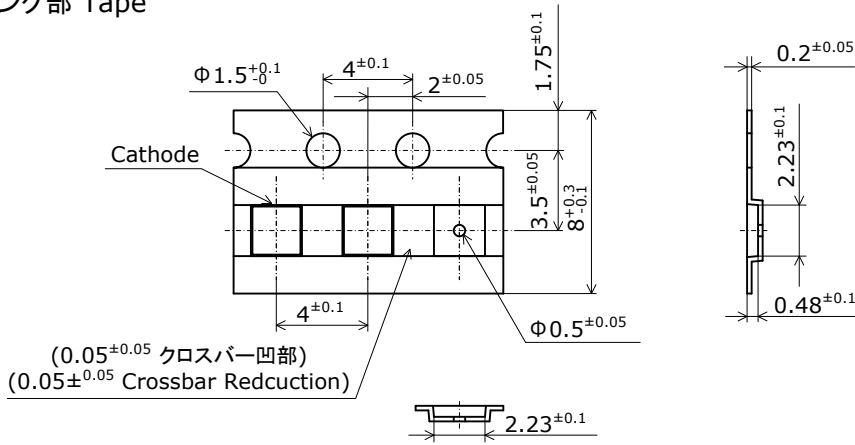

トレーラ部/リーダ部 Trailer and Leader

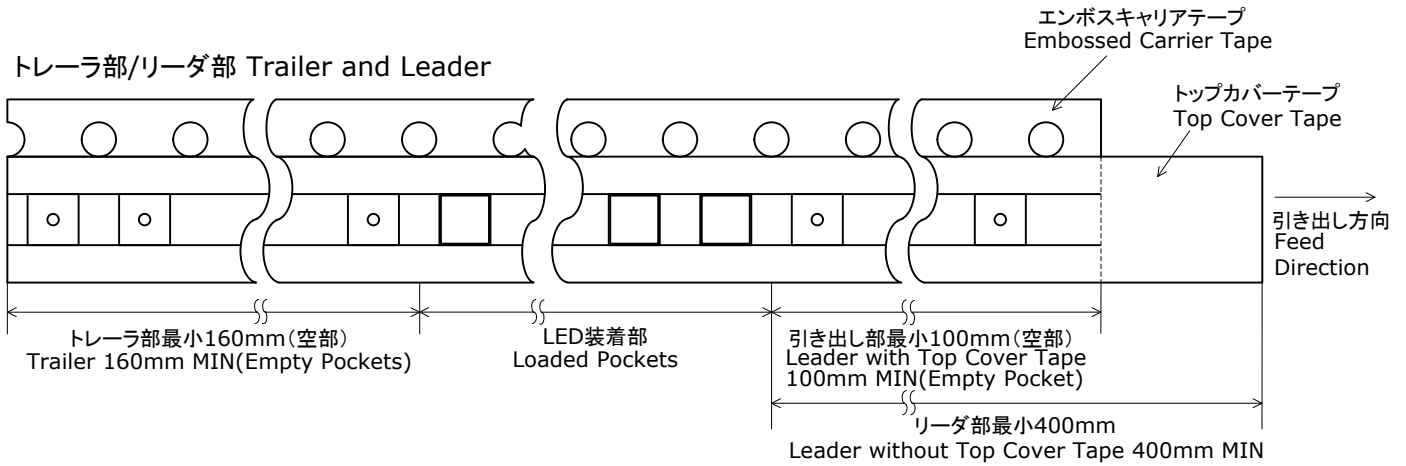

リール部 Reel

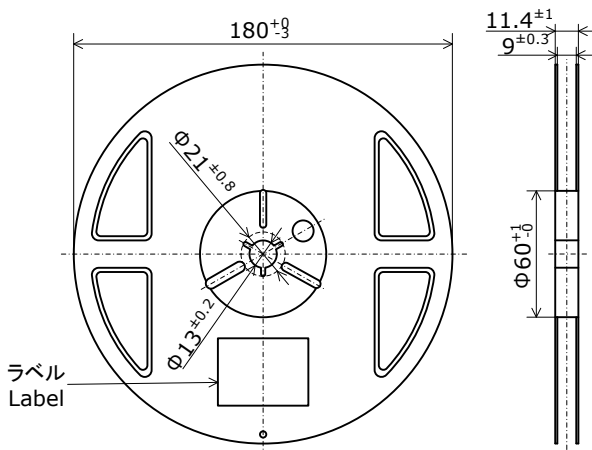

- * 数量は1リールにつき 6000個入りです。
Reel Size: 6000pcs
- * JIS C 0806電子部品テーピングに準拠しています。
The tape packing method complies with JIS C 0806
(Packaging of Electronic Components on Continuous Tapes).
- * 実装作業の中断などでエンボスキャリアテープをリールに巻き取る場合、エンボスキャリアテープを強く(10N以上)締めないで下さい。
LEDがカバーテープに貼り付く可能性があります。
When the tape is rewound due to work interruptions, no more than 10N should be applied to the embossed carrier tape.
The LEDs may stick to the top cover tape.

PACKAGING - TAPE & REEL

シリカゲルとともにリールをアルミ防湿袋に入れ、熱シールにより封をします。
Reels are shipped with desiccants in heat-sealed moisture-proof bags.

Nxxxxxxx
管理番号 No. STS-DA7-4989

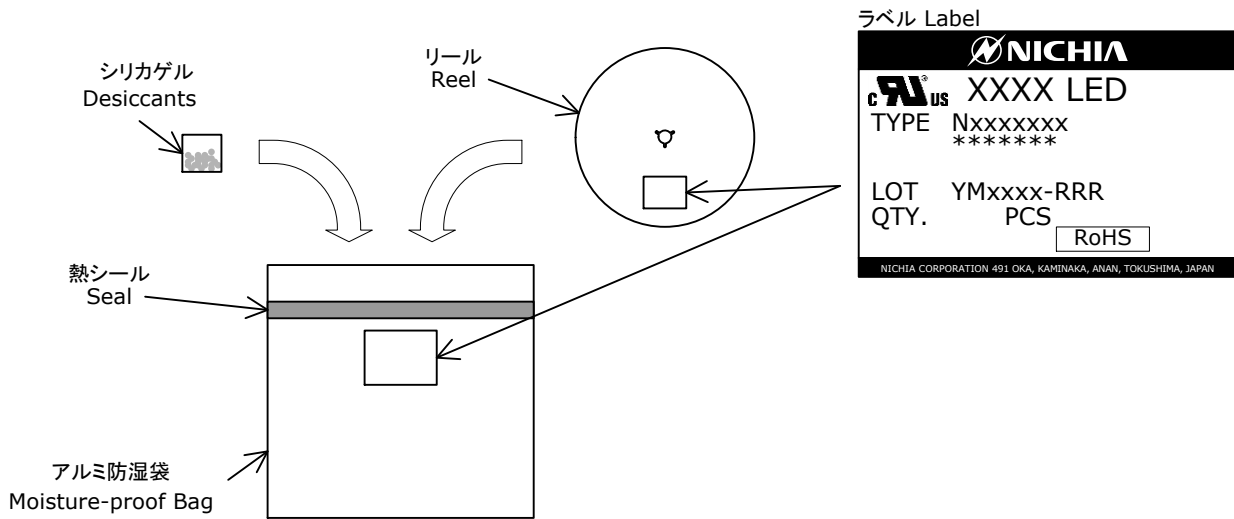

アルミ防湿袋を並べて入れ、ダンボールで仕切ります。
Moisture-proof bags are packed in cardboard boxes with corrugated partitions.

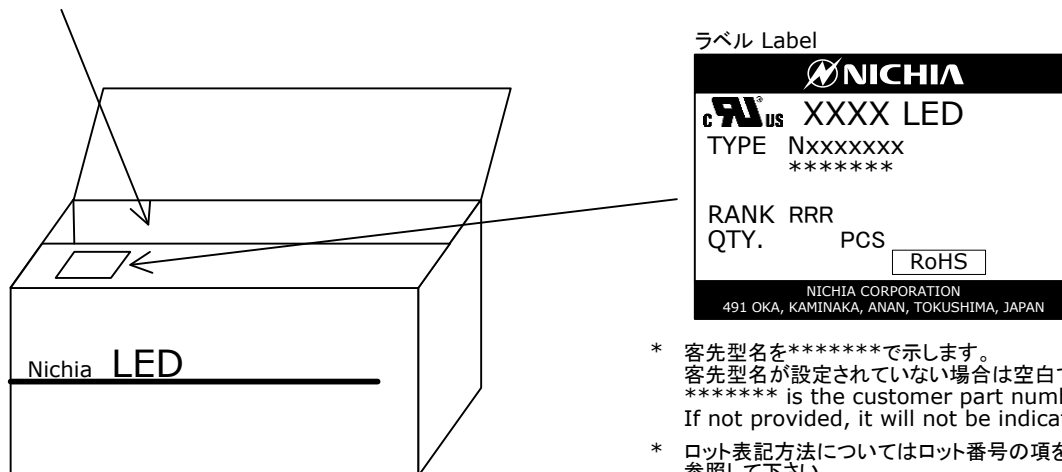

- * 客先型名を*****で示します。
客先型名が設定されていない場合は空白です。
***** is the customer part number.
If not provided, it will not be indicated on the label.
- * ロット表記方法についてはロット番号の項を参照して下さい。
For details, see "LOT NUMBERING CODE" in this document.
- * ランク分けがない場合はランク表記はありません。
The label does not have the RANK field for un-ranked products.

- * 本製品はテーピングしたのち、輸送の衝撃から保護するためダンボールで梱包します。
Products shipped on tape and reel are packed in a moisture-proof bag.
They are shipped in cardboard boxes to protect them from external forces during transportation.
- * 取り扱いに際して、落下させたり、強い衝撃を与えたりしますと、製品を損傷させる原因になりますので注意して下さい。
Do not drop or expose the box to external forces as it may damage the products.
- * ダンボールには防水加工がされておりませんので、梱包箱が水に濡れないよう注意して下さい。
Do not expose to water. The box is not water-resistant.
- * 輸送、運搬に際して弊社よりの梱包状態あるいは同等の梱包を行って下さい。
Using the original package material or equivalent in transit is recommended.

LOT NUMBERING CODE

Lot Number is presented by using the following alphanumeric code.

YMxxxx - RRR

Y - Year

Year	Y
2015	F
2016	G
2017	H
2018	I
2019	J
2020	K

M - Month

Month	M	Month	M
1	1	7	7
2	2	8	8
3	3	9	9
4	4	10	A
5	5	11	B
6	6	12	C

xxxx-Nichia's Product Number

RRR-Ranking by Color Coordinates, Ranking by Luminous Flux, Ranking by Forward Voltage, Ranking by Color Rendering Index

DERATING CHARACTERISTICS

NVSxE21A
管理番号 No. STS-DA7-7888A

周囲温度-許容順電流特性
Ambient Temperature vs
Allowable Forward Current

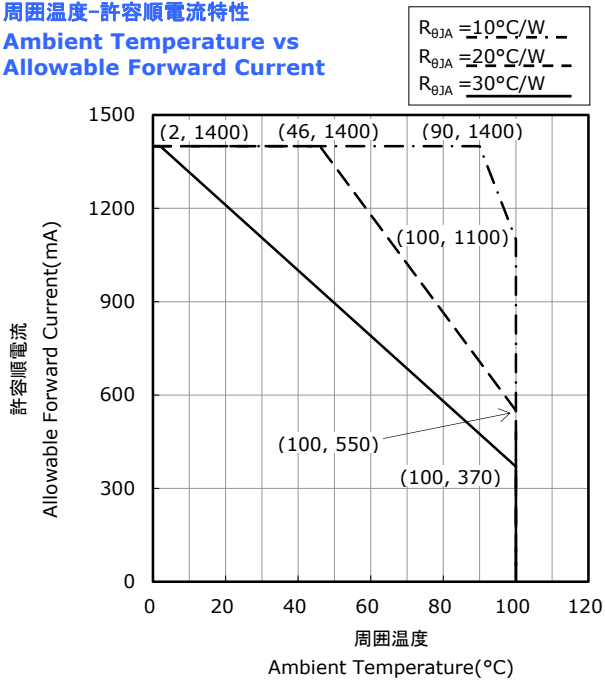

ケース温度測定部温度-許容順電流特性
Temperature at Measure Point on a Case vs
Allowable Forward Current

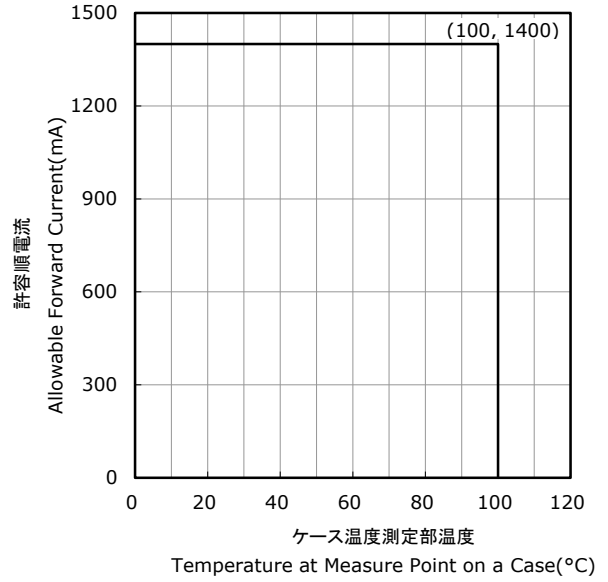

デューティー比-許容順電流特性
Duty Ratio vs
Allowable Forward Current

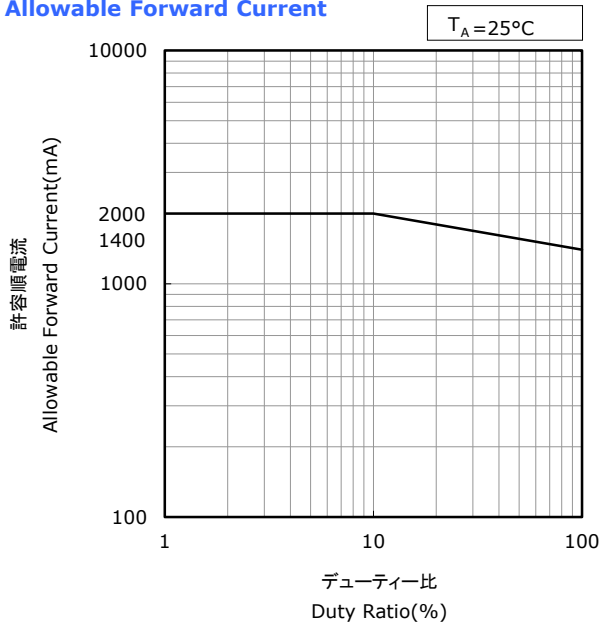

OPTICAL CHARACTERISTICS

* 本特性は参考です。
All characteristics shown are for reference only and are not guaranteed.

NVSLE21A
管理番号 No. STS-DA7-8070

発光スペクトル Spectrum

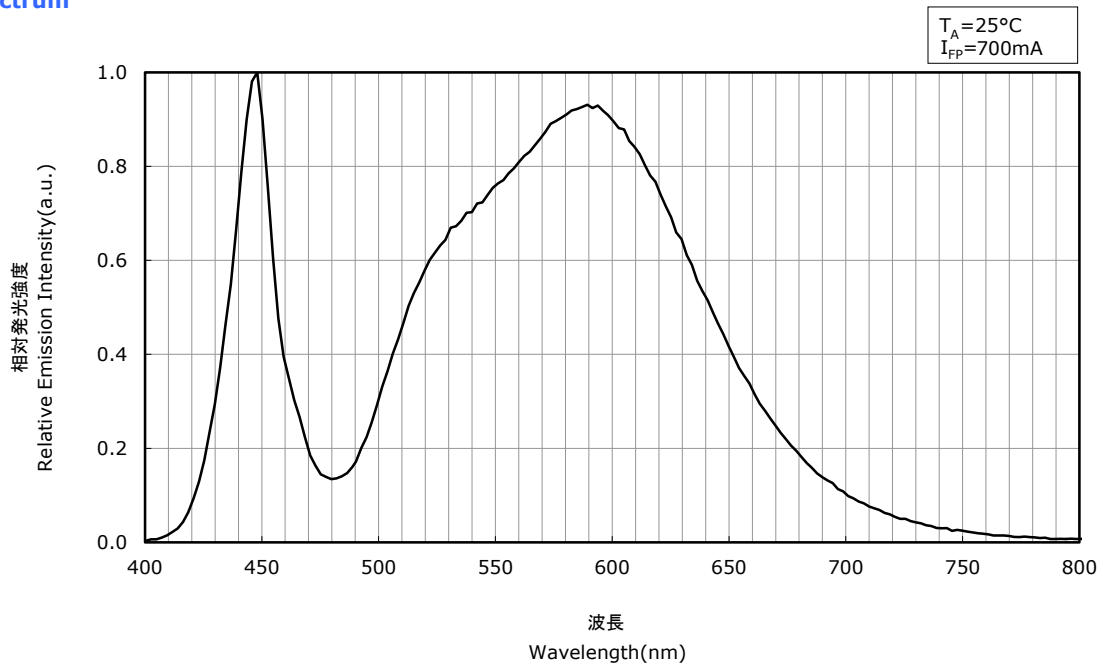

指向特性 Directivity

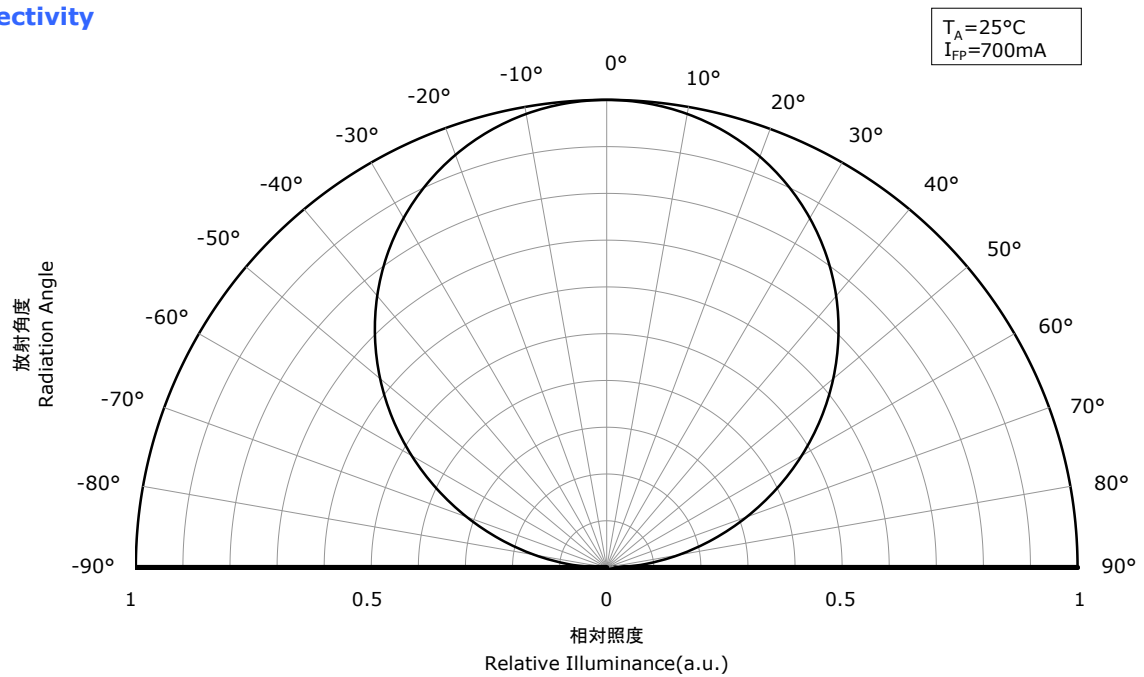

* 本特性は演色性ランクR70に対応しています。
The graphs above show the characteristics for R70 LEDs of this product.

OPTICAL CHARACTERISTICS

* 本特性は参考です。
All characteristics shown are for reference only and are not guaranteed.

NVSLE21A
管理番号 No. STS-DA7-7878A

発光スペクトル Spectrum

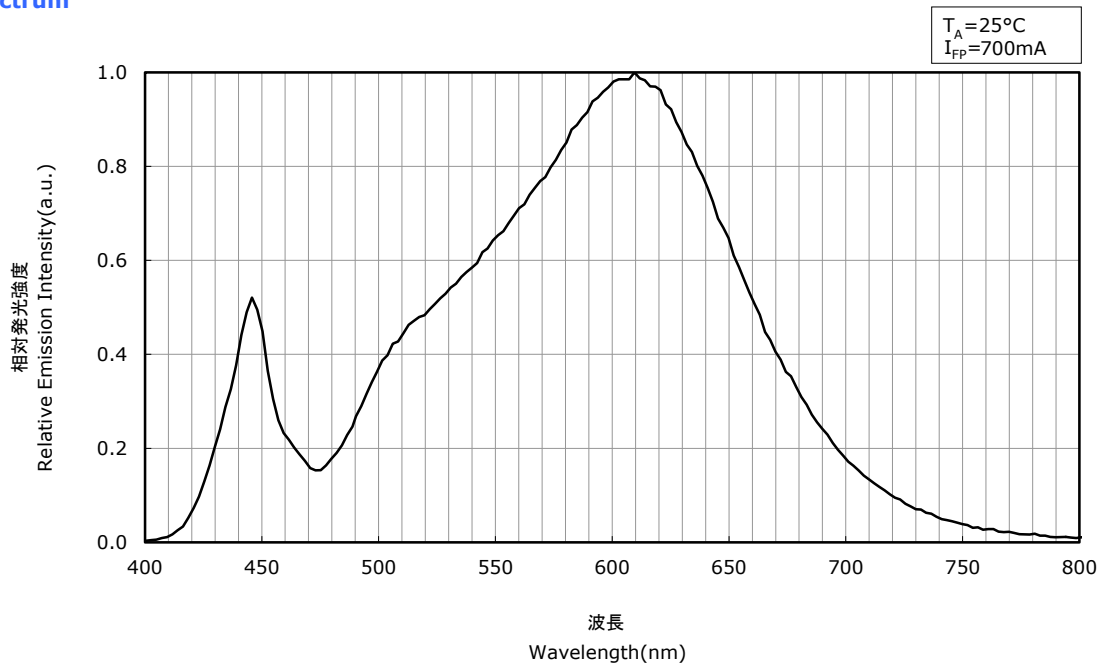

指向特性 Directivity

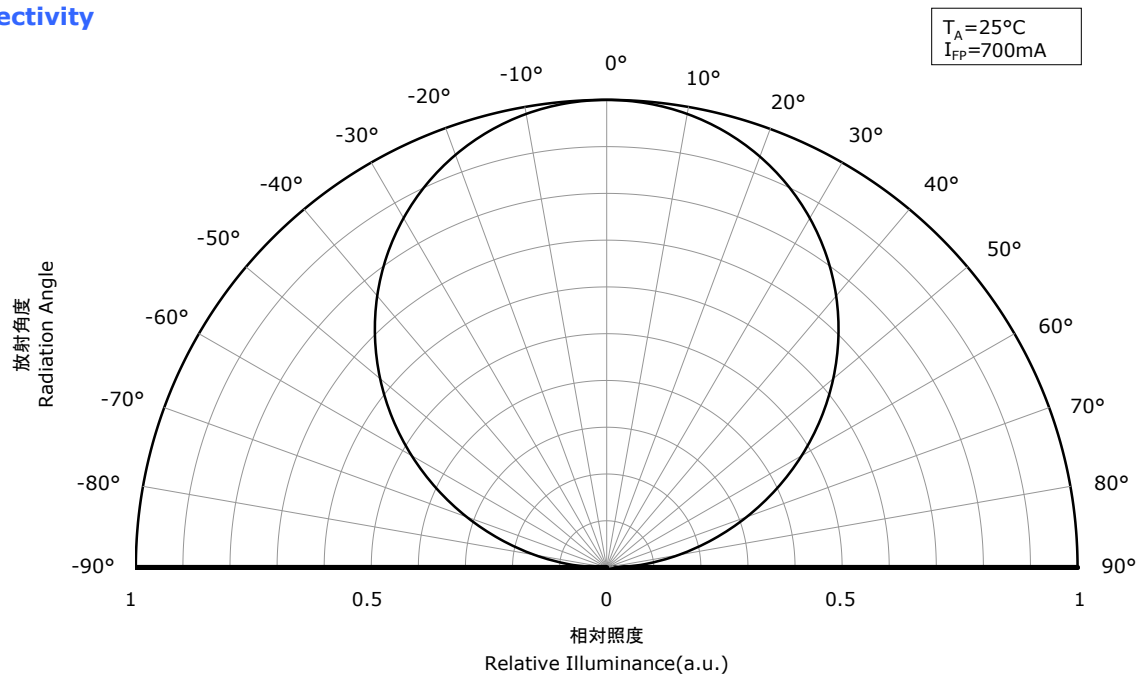

* 本特性は演色性ランクR8000に対応しています。
The graphs above show the characteristics for R8000 LEDs of this product.

OPTICAL CHARACTERISTICS

* 本特性は参考です。
All characteristics shown are for reference only and are not guaranteed.

NVSLE21A
管理番号 No. STS-DA7-8887

発光スペクトル Spectrum

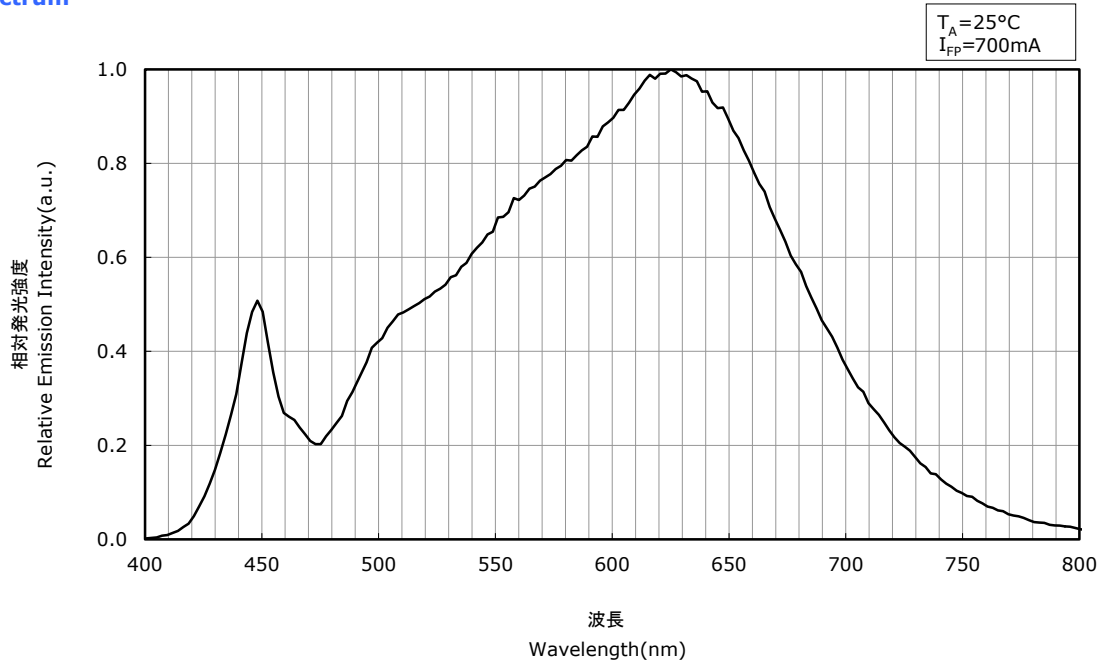

指向特性 Directivity

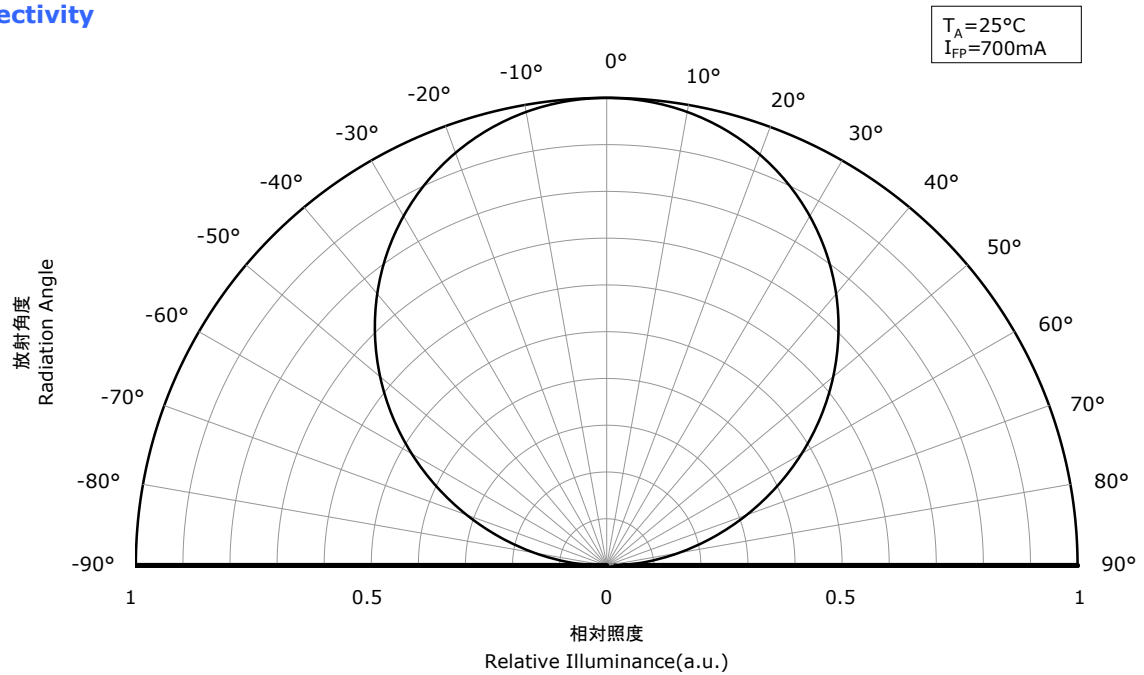

* 本特性は演色性ランクR9050に対応しています。
The graphs above show the characteristics for R9050 LEDs of this product.

OPTICAL CHARACTERISTICS

* 本特性は参考です。
All characteristics shown are for reference only and are not guaranteed.

NVSLE21A
管理番号 No. STS-DA7-9390

発光スペクトル Spectrum

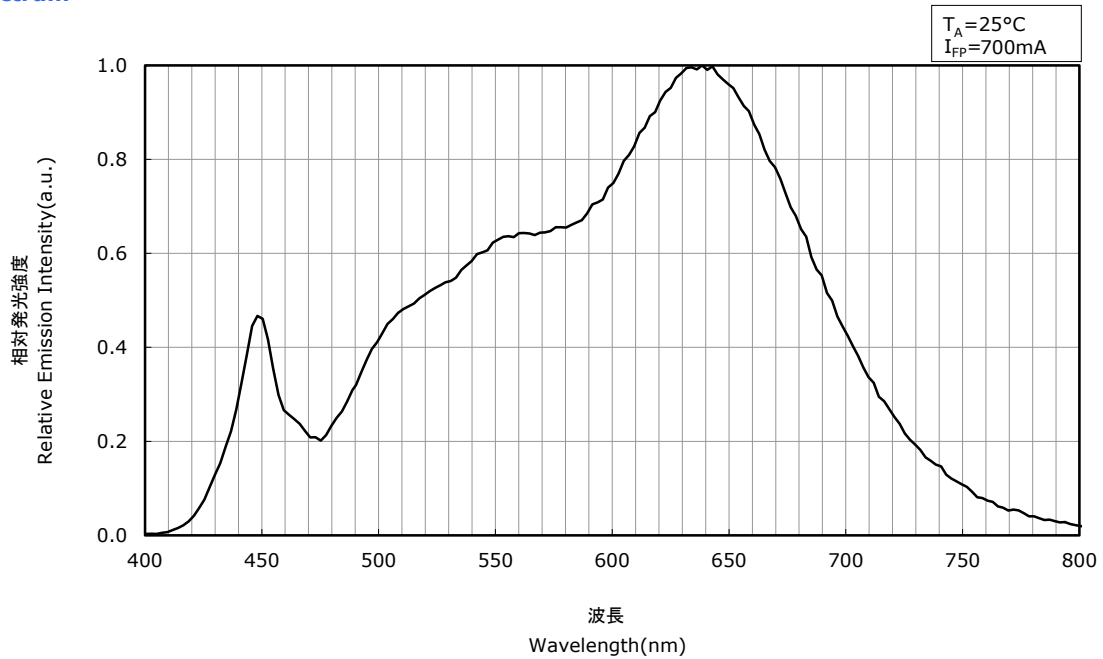

指向特性 Directivity

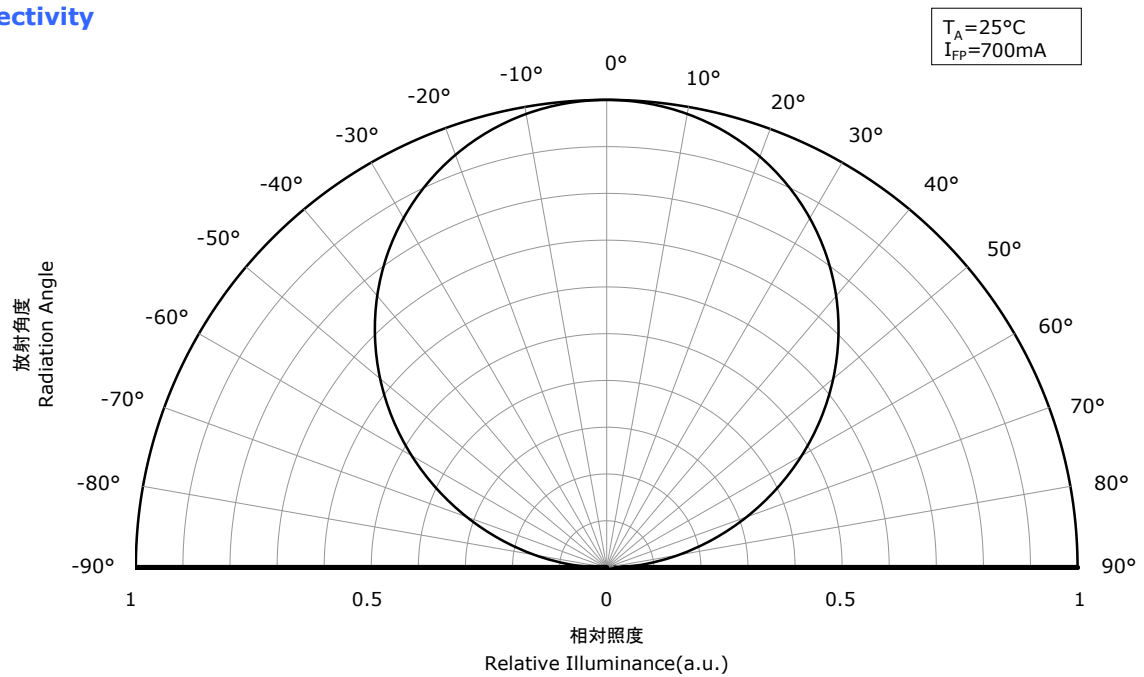

* 本特性は演色性ランクR9080に対応しています。
The graphs above show the characteristics for R9080 LEDs of this product.

FORWARD CURRENT CHARACTERISTICS / TEMPERATURE CHARACTERISTICS

* 本特性は参考です。
All characteristics shown are for reference only and are not guaranteed.

NVSLE21A
管理番号 No. STS-DA7-7879A

順電圧-順電流特性
Forward Voltage vs
Forward Current

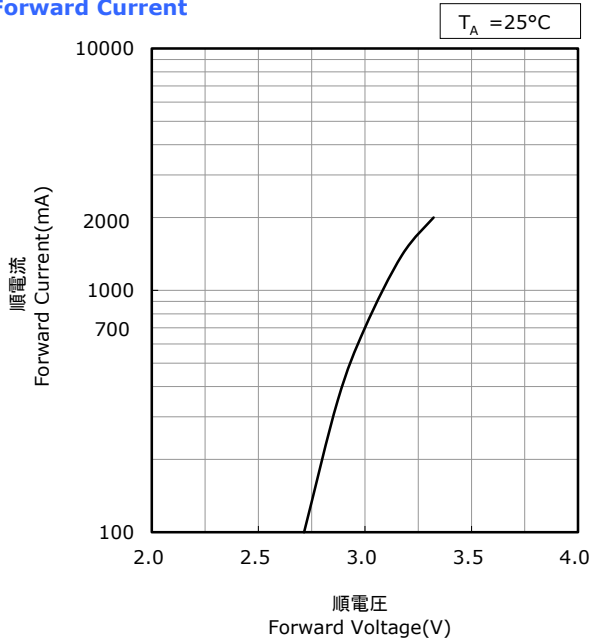

周囲温度-順電圧特性
Ambient Temperature vs
Forward Voltage

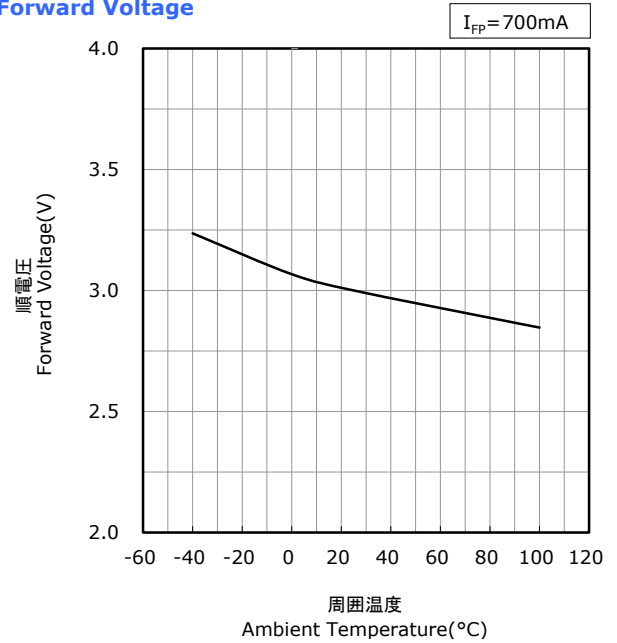

順電流-相対光束特性
Forward Current vs
Relative Luminous Flux

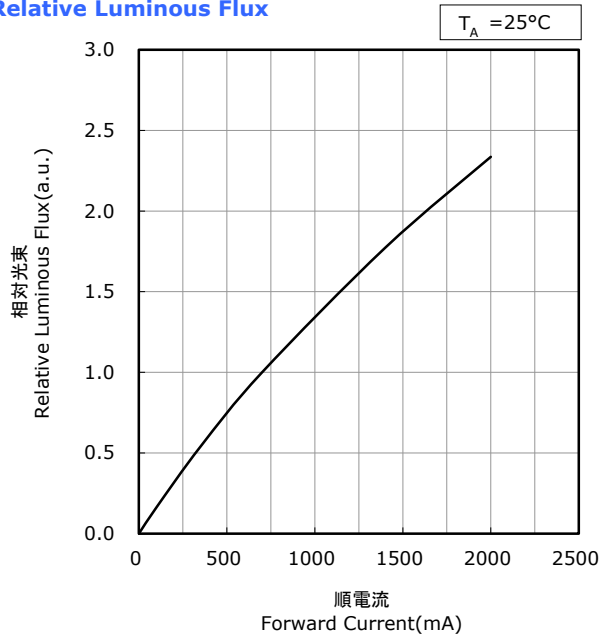

周囲温度-相対光束特性
Ambient Temperature vs
Relative Luminous Flux

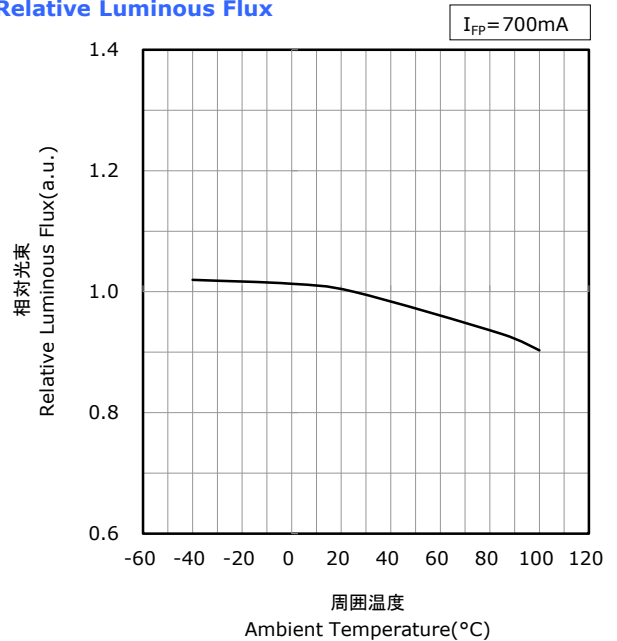

FORWARD CURRENT CHARACTERISTICS / TEMPERATURE CHARACTERISTICS

* 本特性は参考です。
All characteristics shown are for reference only and are not guaranteed.

NVSLE21A
管理番号 No. STS-DA7-8071

順電流-色度 特性
Forward Current vs Chromaticity Coordinate

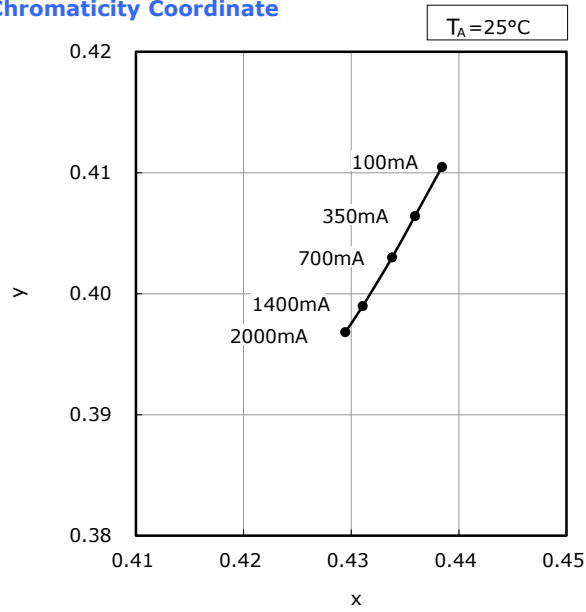

周囲温度-色度 特性
Ambient Temperature vs Chromaticity Coordinate

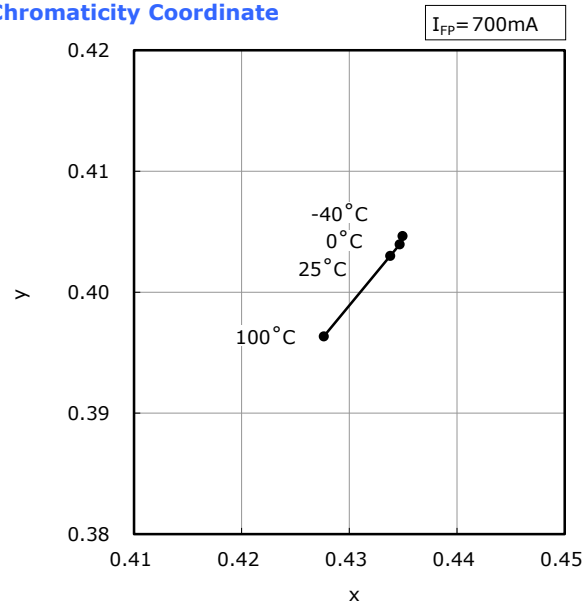

* 本特性は演色性ランクR70に対応しています。
The graphs above show the characteristics for R70 LEDs of this product.

FORWARD CURRENT CHARACTERISTICS / TEMPERATURE CHARACTERISTICS

* 本特性は参考です。
All characteristics shown are for reference only and are not guaranteed.

NVSLE21A
管理番号 No. STS-DA7-7880A

順電流-色度 特性
Forward Current vs Chromaticity Coordinate

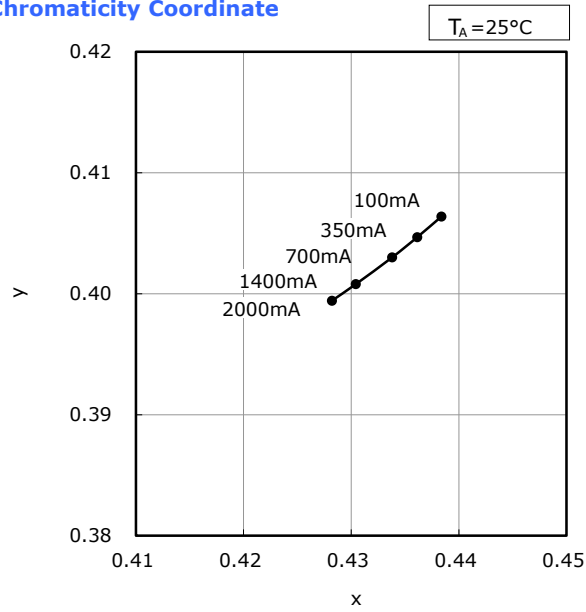

周囲温度-色度 特性
Ambient Temperature vs Chromaticity Coordinate

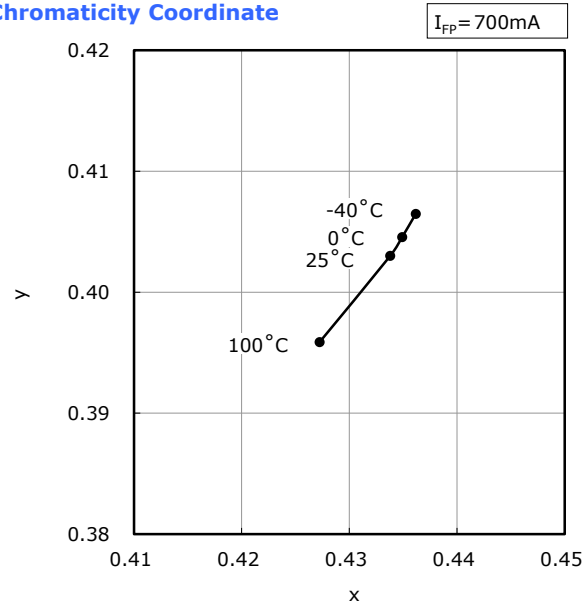

* 本特性は演色性ランクR8000に対応しています。
The graphs above show the characteristics for R8000 LEDs of this product.

FORWARD CURRENT CHARACTERISTICS / TEMPERATURE CHARACTERISTICS

* 本特性は参考です。
All characteristics shown are for reference only and are not guaranteed.

NVSLE21A
管理番号 No. STS-DA7-8888

順電流-色度 特性
Forward Current vs Chromaticity Coordinate

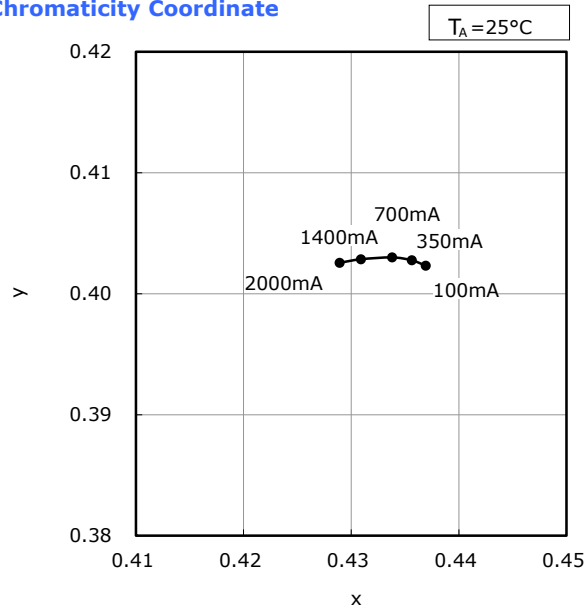

周囲温度-色度 特性
Ambient Temperature vs Chromaticity Coordinate

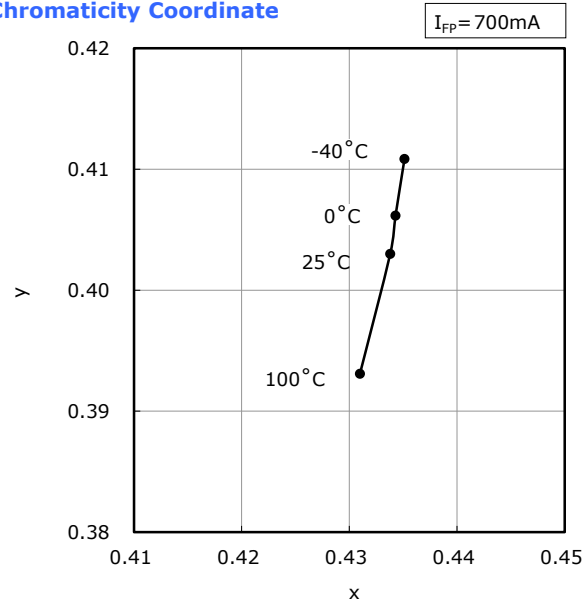

* 本特性は演色性ランクR9050に対応しています。
The graphs above show the characteristics for R9050 LEDs of this product.

FORWARD CURRENT CHARACTERISTICS / TEMPERATURE CHARACTERISTICS

* 本特性は参考です。
All characteristics shown are for reference only and are not guaranteed.

NVSLE21A
管理番号 No. STS-DA7-9391

順電流-色度 特性
Forward Current vs Chromaticity Coordinate

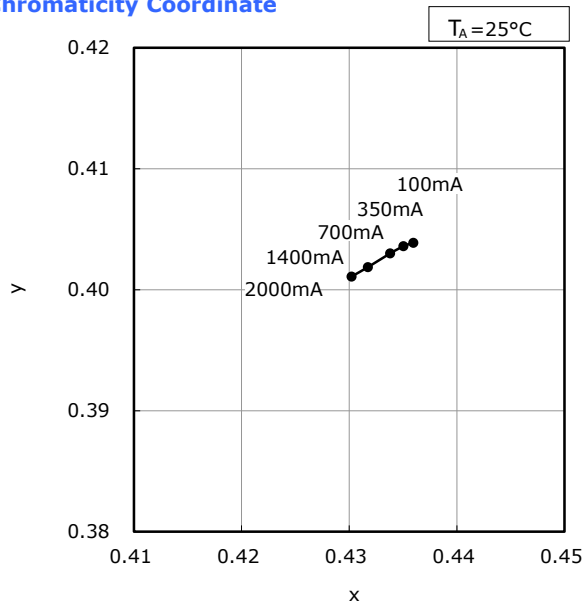

周囲温度-色度 特性
Ambient Temperature vs Chromaticity Coordinate

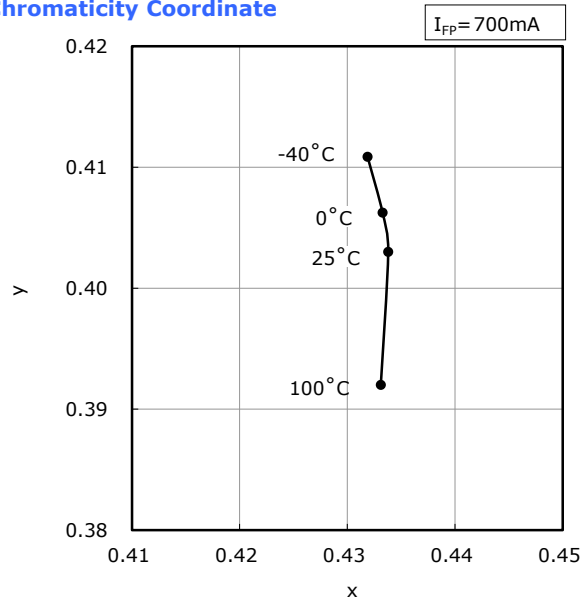

* 本特性は演色性ランクR9080に対応しています。
The graphs above show the characteristics for R9080 LEDs of this product.

RELIABILITY

(1) Tests and Results

Test	Reference Standard	Test Conditions	Test Duration	Failure Criteria #	Units Failed/Tested
Resistance to Soldering Heat (Reflow Soldering)	JEITA ED-4701 300 301	$T_{\text{sid}}=260^{\circ}\text{C}$, 10sec, 2reflows, Precondition: 30°C , 70%RH, 4weeks		#1	0/22
Solderability (Reflow Soldering)	JEITA ED-4701 303 303A	$T_{\text{sid}}=245\pm 5^{\circ}\text{C}$, 5sec, Lead-free Solder(Sn-3.0Ag-0.5Cu)		#2	0/22
Temperature Cycle	JEITA ED-4701 100 105	$-40^{\circ}\text{C}(30\text{min})\sim 25^{\circ}\text{C}(5\text{min})\sim 100^{\circ}\text{C}(30\text{min})\sim 25^{\circ}\text{C}(5\text{min})$	100cycles	#1	0/22
Moisture Resistance (Cyclic)	JEITA ED-4701 200 203	$25^{\circ}\text{C}\sim 65^{\circ}\text{C}\sim -10^{\circ}\text{C}$, 90%RH, 24hr per cycle	10cycles	#1	0/22
High Temperature Storage	JEITA ED-4701 200 201	$T_{\text{A}}=100^{\circ}\text{C}$	1000hours	#1	0/22
Temperature Humidity Storage	JEITA ED-4701 100 103	$T_{\text{A}}=60^{\circ}\text{C}$, RH=90%	1000hours	#1	0/22
Low Temperature Storage	JEITA ED-4701 200 202	$T_{\text{A}}=-40^{\circ}\text{C}$	1000hours	#1	0/22
Room Temperature Operating Life		$T_{\text{A}}=25^{\circ}\text{C}$, $I_{\text{F}}=1100\text{mA}$ Test board: See NOTES below	1000hours	#1	0/22
High Temperature Operating Life		$T_{\text{A}}=100^{\circ}\text{C}$, $I_{\text{F}}=350\text{mA}$ Test board: See NOTES below	1000hours	#1	0/22
Temperature Humidity Operating Life		60°C , RH=90%, $I_{\text{F}}=750\text{mA}$ Test board: See NOTES below	500hours	#1	0/22
Low Temperature Operating Life		$T_{\text{A}}=-40^{\circ}\text{C}$, $I_{\text{F}}=1400\text{mA}$ Test board: See NOTES below	1000hours	#1	0/22
Vibration	JEITA ED-4701 400 403	200m/s^2 , 100~2000~100Hz, 4cycles, 4min, each X, Y, Z	48minutes	#1	0/22
Free Fall		3drops from a height of 75cm		#1	0/22

NOTES:

- 1) Test board: FR4 board thickness=1.6mm, copper layer thickness=35 μm , $R_{\theta\text{JA}}\approx 30^{\circ}\text{C/W}$
- 2) Measurements are performed after allowing the LEDs to return to room temperature.

(2) Failure Criteria

Criteria #	Items	Conditions	Failure Criteria
#1	Forward Voltage(V_{F})	$I_{\text{F}}=700\text{mA}$	>U.S.L. $\times 1.1$
	Luminous Flux(Φ_{V})	$I_{\text{F}}=700\text{mA}$	<L.S.L. $\times 0.7$
	Reverse Current(I_{R})	$V_{\text{R}}=5\text{V}$	>U.S.L. $\times 2.0$
#2	Solderability	-	Less than 95% solder coverage

U.S.L. : Upper Specification Limit L.S.L. : Lower Specification Limit

CAUTIONS

(1) Storage

Conditions		Temperature	Humidity	Time
Storage	Before Opening Aluminum Bag	$\leq 30^{\circ}\text{C}$	$\leq 90\% \text{RH}$	Within 1 Year from Delivery Date
	After Opening Aluminum Bag	$\leq 30^{\circ}\text{C}$	$\leq 70\% \text{RH}$	≤ 4 weeks

- Product complies with JEDEC MSL 2a or equivalent. See IPC/JEDEC STD-020 for moisture-sensitivity details.
- Soldering must be completed within the storage times specified above.
- Absorbed moisture in LED packages can vaporize and expand during soldering, which can cause interface delamination and result in optical performance degradation. Products are packed in moisture-proof aluminum bags to minimize moisture absorption during transportation and storage.
Included silica gel desiccants change from blue to red if moisture had penetrated bags.
- After opening the moisture-proof aluminum bag, the products should go through the soldering process within the range of the conditions stated above. Unused remaining LEDs should be stored with silica gel desiccants in a hermetically sealed container, preferably the original moisture-proof bags for storage.
- Although the leads or electrode pads (anode and cathode) of the product are plated with gold, prolonged exposure to a corrosive environment might cause the gold plated the leads or electrode pads to tarnish, and thus leading to difficulties in soldering. If unused LEDs remain, they must be stored in a hermetically sealed container. Nichia recommends using the original moisture-proof bag for storage.
- Do not use sulfur-containing materials in commercial products. Some materials, such as seals and adhesives, may contain sulfur. The contaminated plating of LEDs might cause an open circuit. Silicone rubber is recommended as a material for seals. Bear in mind, the use of silicones may lead to silicone contamination of electrical contacts inside the products, caused by low molecular weight volatile siloxane.
- To prevent water condensation, please avoid large temperature and humidity fluctuations for the storage conditions.
- Do not store the LEDs in a dusty environment.
- Do not expose the LEDs to direct sunlight and/or an environment where the temperature is higher than normal room temperature.

(2) Directions for Use

- When designing a circuit, the current through each LED must not exceed the Absolute Maximum Rating. Operating at a constant current per LED is recommended. In case of operating at a constant voltage, Circuit B is recommended. If the LEDs are operated with constant voltage using Circuit A, the current through the LEDs may vary due to the variation in Forward Voltage characteristics of the LEDs.

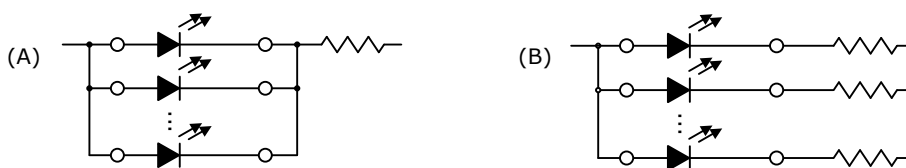

- This product should be operated using forward current. Ensure that the product is not subjected to either forward or reverse voltage while it is not in use. In particular, subjecting it to continuous reverse voltage may cause migration, which may cause damage to the LED die. When used in displays that are not used for a long time, the main power supply should be switched off for safety.
- It is recommended to operate the LEDs at a current greater than 10% of the sorting current to stabilize the LED characteristics.
- Care must be taken to ensure that the reverse voltage will not exceed the Absolute Maximum Rating when using the LEDs with matrix drive.
- Ensure that excessive voltages such as lightning surges are not applied to the LEDs.
- For outdoor use, necessary measures should be taken to prevent water, moisture and salt air damage.

(3) Handling Precautions



- Do not handle the LEDs with bare hands as it will contaminate the LED surface and may affect the optical characteristics: it might cause the LED to be deformed and/or the bump to break, which will cause the LED not to illuminate.
- This product uses encapsulating resin that is very soft. Direct contact with the surface of the resin may cause damage to the resin; the application of force on the resin may cause the wire to break and/or cause the LED not to illuminate. When handling the LEDs with tweezers, make sure to avoid direct contact with the resin and that excessive force is not applied to the LEDs.
- Dropping the product may cause damage.
- Do not stack assembled PCBs together. Failure to comply can cause the resin portion of the product to be cut, chipped, delaminated and/or deformed. It may cause bump to break, leading to catastrophic failures.

(4) Design Consideration

- PCB warpage after mounting the products onto a PCB can cause the package to break. The LED should be placed in a way to minimize the stress on the LEDs due to PCB bow and twist.
- The position and orientation of the LEDs affect how much mechanical stress is exerted on the LEDs placed near the score lines. The LED should be placed in a way to minimize the stress on the LEDs due to board flexing.
- Board separation must be performed using special jigs, not using hands.
- Volatile organic compounds that have been released from materials present around the LEDs (e.g. housing, packing, adhesive, secondary lens, lens cover, etc.) may penetrate the LED lens and/or encapsulating resin. If the LEDs are being used in a hermetically sealed environment, these volatile compounds can discolor after being exposed to heat and/or photon energy and it may greatly reduce the LED light output and/or cause a color shift. In this case, ventilating the environment may improve the reduction in light output and/or color shift. Perform a light-up test of the chosen application for optical evaluation to ensure that there are no issues, especially if the LEDs are planned to be used in a hermetically sealed environment.
- Ensure that the chosen land pattern has a solder mask which does not cover the copper pads that the LED will be attached to or the area underneath the LED.

(Non Solder Mask Defined [NSMD] pads are recommended, see the figure below.)

Refer to the relevant application notes. To access the application notes, go to the Technical Suggestions And Recommendations section of Nichia’s website.

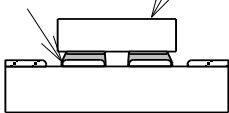
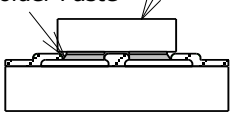
	NSMD(推奨 Recommended)	SMD(参考 Reference)
製品実装前 Before Mounting the LED	ソルダーレジスト 銅箔パッド Solder Mask Copper Pad 	ソルダーレジスト 銅箔パッド Solder Mask Copper Pad 
製品実装後 After Mounting the LED	はんだペースト 製品 LED Solder Paste LED 	はんだペースト 製品 LED Solder Paste LED 

(5) Electrostatic Discharge (ESD)

- The products are sensitive to static electricity or surge voltage. ESD can damage a die and its reliability.
When handling the products, the following measures against electrostatic discharge are strongly recommended:
 - Eliminating the charge
 - Grounded wrist strap, ESD footwear, clothes, and floors
 - Grounded workstation equipment and tools
 - ESD table/shelf mat made of conductive materials
- Ensure that tools, jigs and machines that are being used are properly grounded and that proper grounding techniques are used in work areas. For devices/equipment that mount the LEDs, protection against surge voltages should also be used.
- If tools or equipment contain insulating materials such as glass or plastic, the following measures against electrostatic discharge are strongly recommended:
 - Dissipating static charge with conductive materials
 - Preventing charge generation with moisture
 - Neutralizing the charge with ionizers
- The customer is advised to check if the LEDs are damaged by ESD when performing the characteristics inspection of the LEDs in the application.
Damage can be detected with a forward voltage measurement or a light-up test at low current ($\leq 1\text{mA}$).
- ESD damaged LEDs may have an increased leakage current, current flow at a low voltage or no longer illuminate at a low current.
Failure Criteria: $V_F < 2.0\text{V}$ at $I_F = 0.5\text{mA}$

(6) Thermal Management

- Proper thermal management is an important when designing products with LEDs. LED die temperature is affected by PCB thermal resistance and LED spacing on the board. Please design products in a way that the LED die temperature does not exceed the maximum Junction Temperature (T_J).
- Drive current should be determined for the surrounding ambient temperature (T_A) to dissipate the heat from the product.
- The following equations can be used to calculate the junction temperature of the products.

$$1) T_J = T_A + R_{\theta JA} \cdot W \quad 2) T_J = T_C + R_{\theta JC} \cdot W$$

* T_J = LED junction temperature: °C

T_A = Ambient temperature: °C

T_C = Case temperature: °C

$R_{\theta JA}$ = Thermal resistance from junction to ambient: °C/W

$R_{\theta JC}$ = Thermal resistance from junction to T_C measuring point: °C/W

W = Input power ($I_F \times V_F$): W

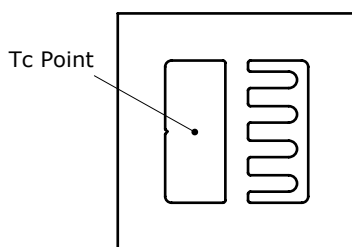

- Once the LEDs have been soldered to a PCB, it is difficult to measure T_C due to the location of the T_C measurement point.
Refer to the relevant application notes for other methods of determining the T_J . To access the application notes, go to the Technical Suggestions And Recommendations section of Nichia's website.

(7) Cleaning

- The LEDs should not be cleaned with water, benzene, and/or thinner.
- If required, isopropyl alcohol (IPA) should be used. Other solvents may cause premature failure to the LEDs due to the damage to the resin portion. The effects of such solvents should be verified prior to use.
In addition, the use of CFCs such as Freon is heavily regulated.
- When dust and/or dirt adheres to the LEDs, soak a cloth with Isopropyl alcohol (IPA), then squeeze it before wiping the LEDs.
- Ultrasonic cleaning is not recommended since it may have adverse effects on the LEDs depending on the ultrasonic power and how LED is assembled.
If ultrasonic cleaning must be used, the customer is advised to make sure the LEDs will not be damaged prior to cleaning.

(8) Eye Safety

- In 2006, the International Electrical Commission (IEC) published IEC 62471:2006 Photobiological safety of lamps and lamp systems, which added LEDs in its scope.
On the other hand, the IEC 60825-1:2007 laser safety standard removed LEDs from its scope.
However, please be advised that some countries and regions have adopted standards based on the IEC laser safety standard IEC 60825-1:2011/2001, which still includes LEDs in its scope.
Most of Nichia's LEDs can be classified as belonging into either the Exempt Group or Risk Group 1.
High-power LEDs, that emit light containing blue wavelengths, may be classified as Risk Group 2.
Please proceed with caution when viewing directly any LEDs driven at high current, or viewing LEDs with optical instruments which may greatly increase the damages to your eyes.
- Viewing a flashing light may cause eye discomfort. When incorporating the LED into your product, please be careful to avoid adverse effects on the human body caused by light stimulation.

(9) Others

- This product is intended to be used for general lighting, household appliances, electronic devices (e.g. mobile communication devices); it is not designed or manufactured for use in applications that require safety critical functions (e.g. aircraft, automobiles, combustion equipment, life support systems, nuclear reactor control system, safety devices, spacecraft, submarine repeaters, traffic control equipment, trains, vessels, etc.). If the LEDs are planned to be used for these applications, unless otherwise detailed in the specification, Nichia will neither guarantee that the product is fit for that purpose nor be responsible for any resulting property damage, injuries and/or loss of life/health.
This product does not comply with ISO/TS 16949 and is not intended for automotive applications.
- The customer shall not reverse engineer by disassembling or analysis of the LEDs without having prior written consent from Nichia. When defective LEDs are found, the customer shall inform Nichia directly before disassembling or analysis.
- The specifications and appearance of this product may change without notice;
Nichia does not guarantee the contents of this specification. Both the customer and Nichia will agree on the official specifications of supplied products before the volume production of a program begins.